

Rack Pinion Actuator 30mm Stroke

15mm Input Shaft • 20mm Output Shaft • Capacity 60kgf

Actuator

When input shaft is rotated this is translated into linear movement of the rack up to its stroke range.

Ondrives are able to manufacture the RPA style with different strokes by RFQ.

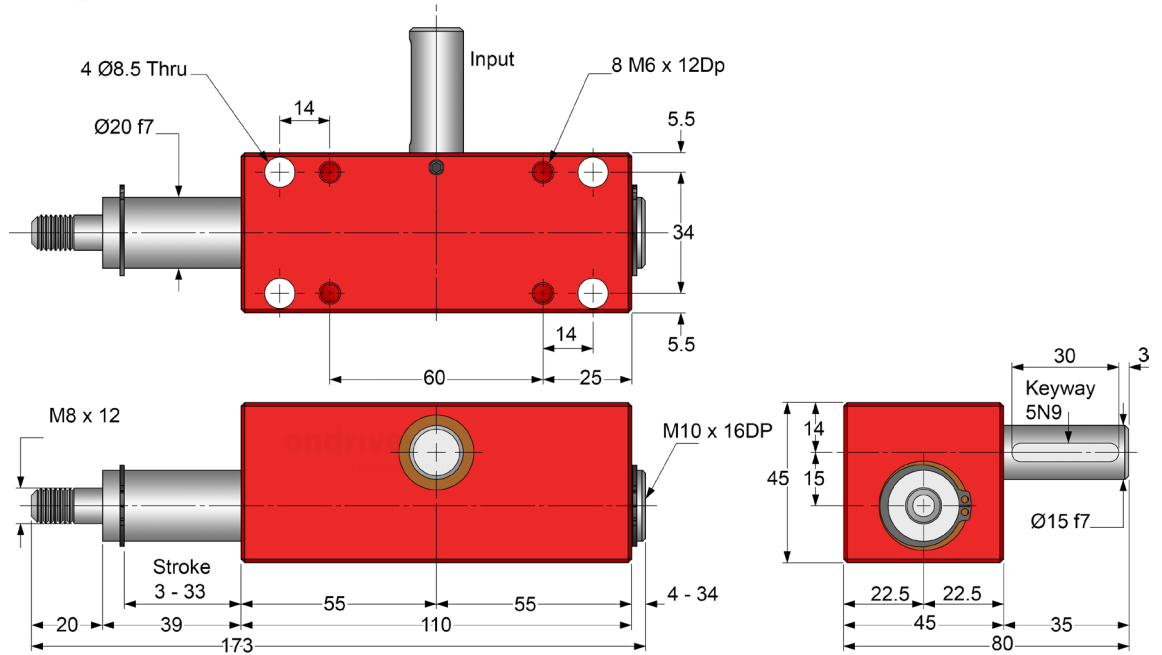
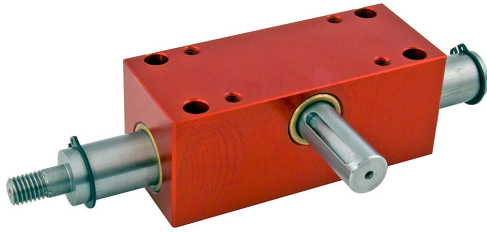

Part Numbers					
Output Backlash j	Input Torque	Stroke Movement	Load Capacity Max.	1mm Travel Input Rotation	10mm Stroke Input Rotation
≤2°	Nm	mm	kgf	°	°
RPA20-30	5.20	30	60	6.55	196.5

Weight: ?? kg.

Lubrication: Grease Shell Gadus S5 V42P 2.5

Testing in your application is necessary.
You will need to assess duty cycles and confirm suitability with your own calculations.
Figures listed are for guidance only.